

COSMOS 300

User manual

release V2/2022

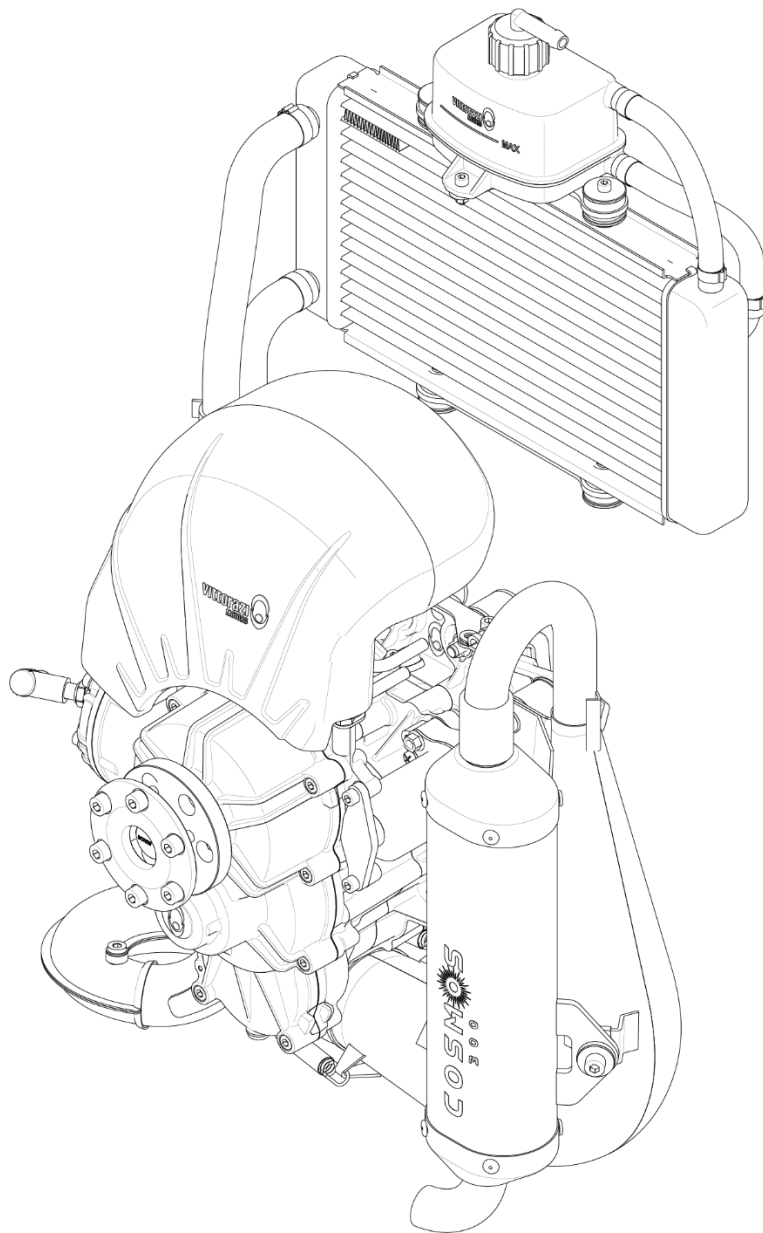

Contents

1	Introduction	4
2	Be careful! Read it completely	6
3	Cosmos 300: What is it?	8
	3.1 Engine serial number	8
	3.2 Technical data	9
4	How to use it?	12
	4.1 Propeller assembling	12
	4.2 Fuel	15
	4.3 Start and stop	17
	4.4 Engine warm up	20
	4.5 Break-in procedure	21
5	Safety first, check it	24
	5.1 Maintenance schedule	24
	5.2 Tightening values	28
	5.3 Carburettor setting	30
	5.4 Pre-flight checklist	33
	5.5 Spare parts	34
6	Warranty	35
	6.1 Warranty limits	35
	6.2 Warranty procedure	35
	6.3 Warranty coverage	36
	6.4 Contacts	38

1 Introduction

Congratulations and thanks for choosing a Vittorazi Motors engine.

The User Manual is part of the engine and must be preserved and attached to the engine if the engine is transferred to a new user. The purpose of this manual is to provide all the necessary information to the user in order to enable a proper use of the engine, carried out autonomously and in total security. The User Manual includes: technical descriptions of the operating modes, scheduled maintenance table and reference values; suggestions and safety measures to which the user is subjected are also included.

All the components of Vittorazi Motors are checked and tested in a process of industrial quality control before the assembling. Then by sampling the complete motors are checked to assure the functionality of all the parts through a complete test of twenty minutes on the bench. Note that the reliability, performance and durability of the engine also depend on proper use of the engine during time. Vittorazi Motors is always improving its engines and reserves the right to change in any moment and without notice, drawings, specifications, components and details of the models in production without any obligation towards the user.

In case you need further explanations, you can contact the authorized dealer of your country. Please include in the request, the six-digit serial number that identifies the motor (read 3.1 "Engine serial number") and a photo of the item in question.

Also take into account the availability of Illustrated Parts Catalogue (IPC), manual updates, service bulletins, FAQs, other documents in our official website. The video tutorials are available on the Vittorazi Motors official YouTube channel. Below the links.

Find the nearest dealer

www.vittorazi.com/en/dealers/



IPC, manuals, bulletins, newsletter, warranties, FAQ

<https://www.vittorazi.com/en/services/>



Vittorazi Official YouTube channel: video and free tutorials available

<https://www.youtube.com/user/VITTORAZIMOTORS>



Reading tips:

Attention, danger, risk

Any situation or condition which may result in a serious danger



Recommendation, warning, important advice



2 Be careful! Read it completely



To fly in total safety, you must read the following recommendations:

- This engine is not certified. This engine does not fulfil airworthiness regulations. The products are dedicated to non-certified aircraft and flying as a recreational or sporting activity.
- Final-user must be aware that the engine can stop, break or shut down at any time. Such an event may require an immediate and forced landing in inadequate, congested or impervious areas, with the possibility in the end of causing the death of the pilot or other persons involved.
- The aircraft equipped with this engine must be conducted in full compliance with rules and regulations in force relating to the activity of leisure and sport aviation, with regard to the country in which the operations are carried out.
- Vittorazi Motors and its distributors decline any direct or indirect responsibility related to this kind of activity. By using a new engine, the owner agrees that these terms and conditions have been accepted at the time of purchase of the product.
- The engine is not covered by any liability insurance. The use of the engine automatically determines the assumption of all risks and personal liability for personal injury or damage to third parties resulting from the activity.
- Improper use of the products or improper technical service (in relation to the specifications contained in the user, installation and maintenance manual) will held harmless the company from any liability for any damage due to the malfunctioning and immediately void the warranty of the product. So, do not use the motor if it has not been properly maintained or if it has not been used correctly over time.
- Vittorazi does not assume any responsibility for those engines that are used with parts that are not original, not approved, modified or that have suffered an improper use. Use of spare parts not original and not recognized by Vittorazi, can make the engine dangerous and will void the warranty.
- Unauthorized modifications to the motor, to the reduction, to the propeller can invalidate the warranty of the motor and can compromise the reliability of the aircraft and its safety. In case it is necessary to intervene, we invite you to contact an authorized dealer Vittorazi.
- Some geographical areas, due to particular weather conditions such as pressure, temperature and humidity can affect the performance of the engine. Before taking off, test the engine on the ground and make sure it does not behave abnormally.

- Always start the engine on a flat and clean surface, without stones or sand. During all phases in which the engine is kept running near the ground (such as heating, take off, landing) it is necessary to maintain a safe distance from the engine. A good safety distance is 100 meters in every direction.



The following engine speed limits must be respected to avoid engine failures, to keep the warranty valid and to have a correct maintenance scheduling according to the Vittorazi program:

- Do not keep the engine at full revs for more than 60 seconds.
- Do not keep revs higher than 6.500 RPM during long cruising flights or long climbs. The average power delivered by the engine during a flight should remain below the indicated threshold. Contact the aircraft manufacturer for further clarification.



For the proper engine operation, the coolant temperature measured by the head sensor must be within the limits indicated below. In case of a temperature outside the indicated thresholds (Min; Max), contact the aircraft manufacturer.

- Max 90 °C.
- Min 65 °C.



The temperature limit of EGT is 650° Celsius. Do not persist above this temperature threshold, engine overheating and irreversible damage could occur.

3 Cosmos 300: What is it?

Cosmos 300 is a single cylinder, two-stroke piston engine, liquid cooled and fuelled with a mixture of gasoline and oil.

Power is transmitted from the crankshaft to the propeller shaft through a reduction ratio with spur gear system. The air inlet system consists of an airbox and a filter. Mixture of gasoline and oil is introduced in the cylinder through a diaphragm carburettor system. The carburettor has been calibrated before delivery in combination with this engine.

This manual is intended for the engine Cosmos 300 in all versions listed below:

- **MY21 (first version)**
 - **Single Spark, Manual starter;**
 - **Single Spark, Dual starter;**
 - **Twin Spark, Dual starter.**

3.1 Engine serial number

The serial code of your engine is located on the engine carter case, between the cylinder and the airbox.

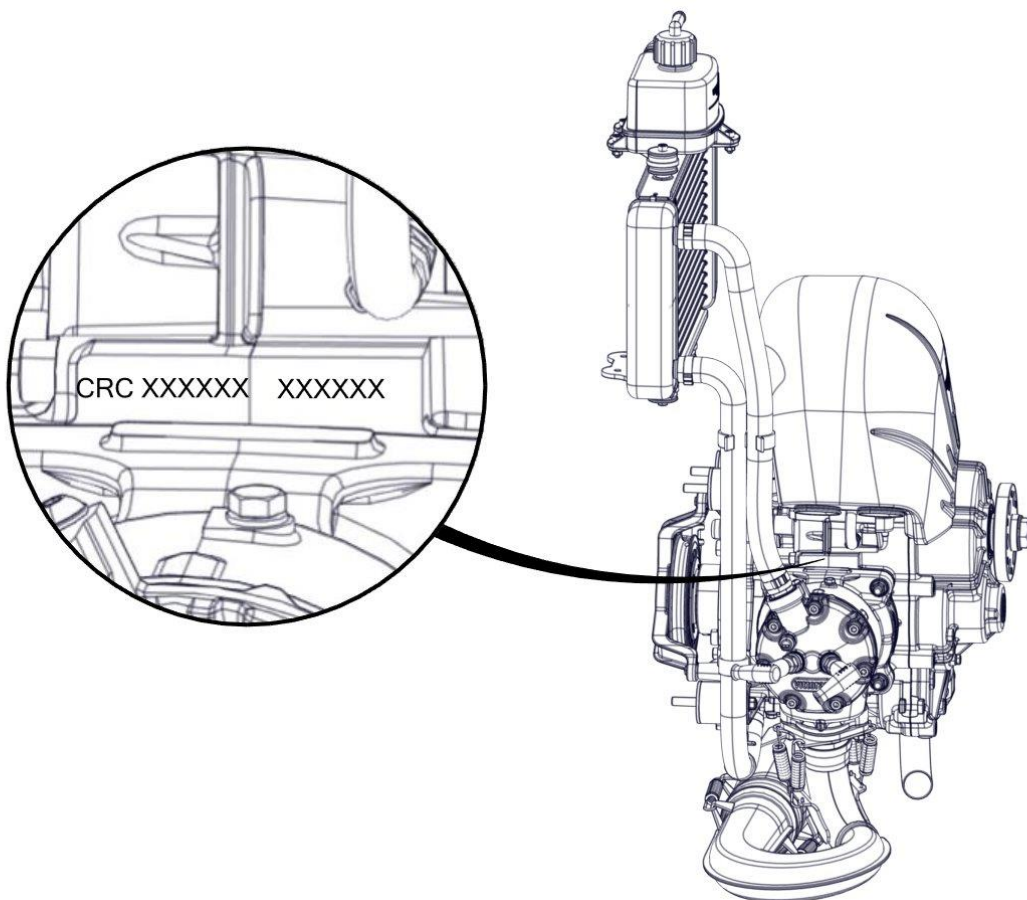

3.2 Technical data

Cosmos 300	
Cycle	2 strokes
Stroke	60 mms
Displacement	293,9 cc
Bore	Ø 79 mms
Power	36 HP at 7.500 RPM
Cylinder	Single cylinder in aluminum; electroplated with hard coating Nikasil® technology
Piston	Forged piston, diamond profile, Molybdenum Disulphide (MOS2) coating on the piston skirt, 2 rings chromed
Air intake	Airbox silencer Diaphragm carburettor, integrate choke system Reed valve intake
Cooling system	Liquid cooling
Starter	Manual: 3S (Soft Starter System) Dual: Electric Starter + 3S (Soft Starter System)
Transmission	Oil lubricated spur gear system Centrifugal clutch
Reduction	1/3,04
Balancing system	Counter-rotating shaft
Ignition	Single Spark or Twin Spark version
Spark plug	NGK BR9ES
Max. EGT (Exhaust Gas Temperature)	EGT 650 °C (measured at 21 cms from the piston)
Max. coolant temperature	90 °C
Maximum RPM	7.300-7.650 RPM*
Engine idle	1.800-2.000 RPM
Static thrust	124 kgs prop. 160 cms at 7.500 RPM (3 blades Vittorazi Approved Prop) 116 kgs prop. 150 cms at 7.450 RPM (2 blades Vittorazi Approved Prop) 110 kgs prop. 140 cms at 7.450 RPM (3 blades Vittorazi Approved Prop)
Exhaust pipe	Tuned exhaust system, ceramic powder coating Double joint system, double rib reinforcement system Silencer pipe in anodized aluminum. EGT sensor threaded hole Optimized noise reduction
Propeller rotation	Clockwise
Fuel	Unleaded gasoline with 2,0 % synthetic oil (Motul710) Unleaded gasoline with 1,5 % synthetic oil (Motul800)

The table follows in the next page

Fuel consumption	3,2 litres/hour, at 40 kgs of static thrust, prop. 160 cms at 4.500 RPM (2 blades Vittorazi Approved Prop) 8,5 litres/hour, at 75 kgs of static thrust, prop. 160 cms at 6.000 RPM (2 blades Vittorazi Approved Prop)
Weight	Single Spark, Manual: 25,0 kgs Single Spark, Dual: 26,5 kgs Twin Spark, Dual: 27,0 kgs (full weight, radiator included, liquid excluded)

* Maximum RPM depends on the propeller used:

- 140 cms, 3 blades: 7.450-7.650 RPM;
- 150 cms, 2 blades: 7.350-7.550 RPM;
- 150 cms, 3 blades: 7.300-7.500 RPM;
- 160 cms, 2 blades: 7.400-7.600 RPM;
- 160 cms, 3 blades: 7.350-7.550 RPM.

Example curves of performance follow (data are taken at temperature, pressure and relative humidity shown in the graph). Propeller used is an approved Helix propeller, 160 cms diameter, 2 blades.

Thrust [kg] @ 11,5 °C, 73 % RH, 1003 mbar
160 cms propeller, 2 blades

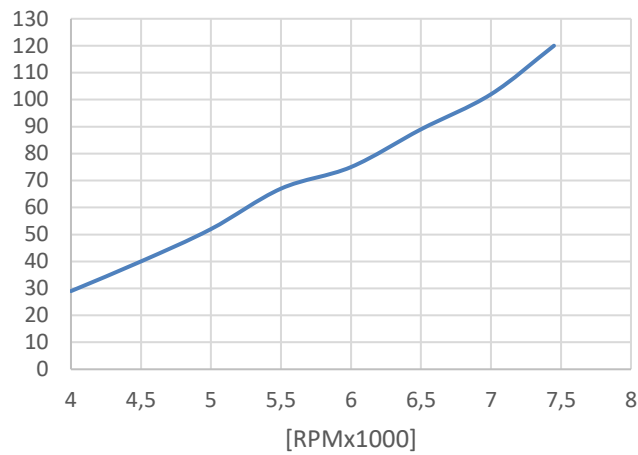

Fuel Consumption [lt/h]

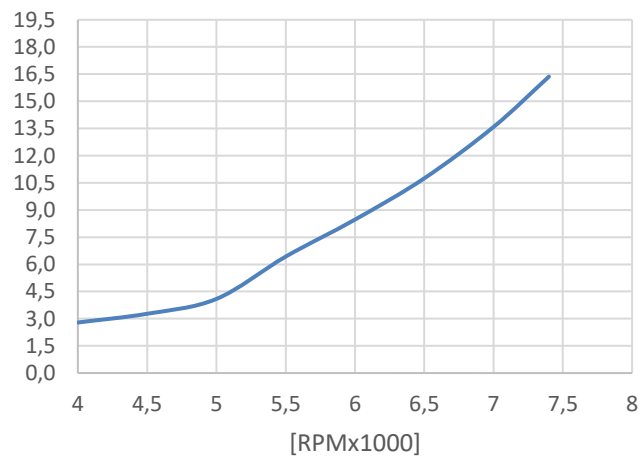

EGT [°C]

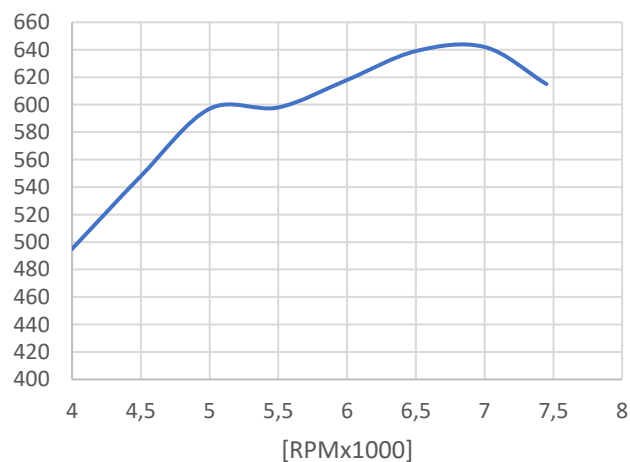

4 How to use it?

4.1 Propeller assembling

Considering the rear view, the propeller rotation is clockwise. As first operation, couple the two blades in the bayonet recess as shown, then add the screws and the flange. Lastly, place the bottom of the propeller on the reduction hub and tighten the screws progressively until they reach the stop.



The spacer between the hub and the propeller is not authorised for this engine model.

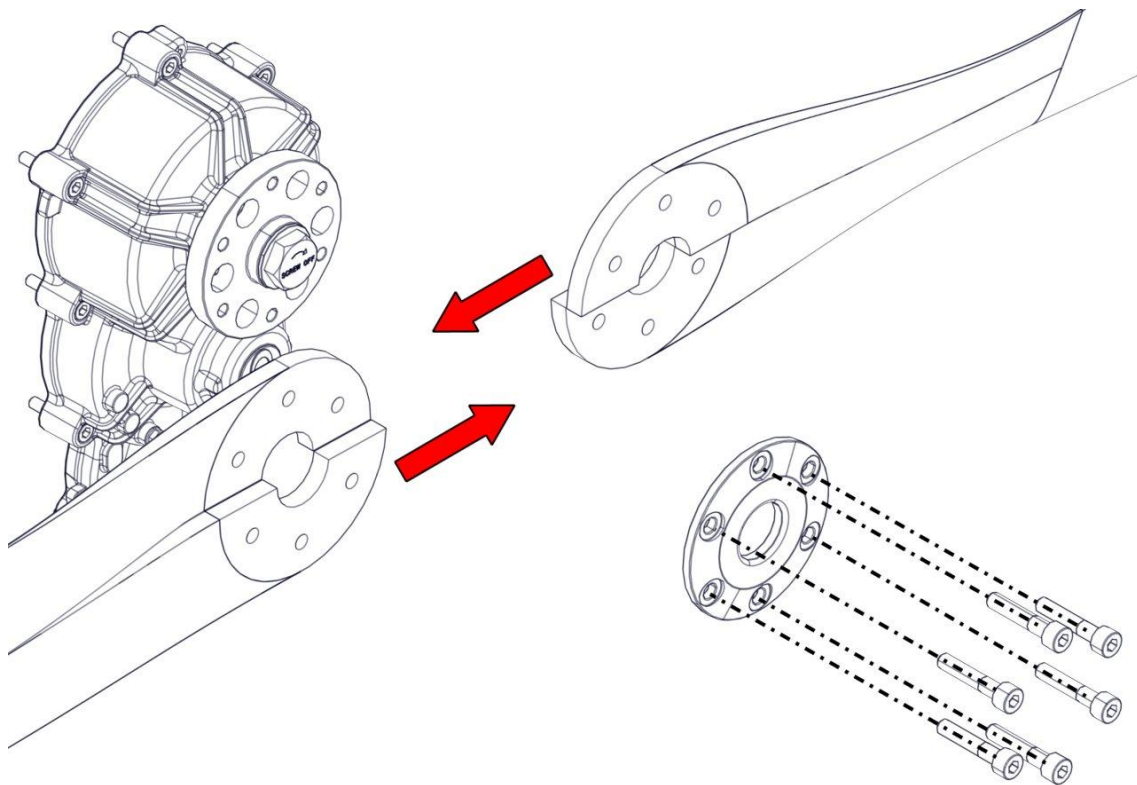



Propeller screws tightening values:

- Carbon-fibre propeller: **12-14 Nm** on each screw M8.

Ask an authorized dealer or the instructor if you are not sure about the propeller assembling. **It is very important to check the tightening of the propeller screws before take-off and after landing.**



Be sure that the screws are suitable to the propeller in use: the thread of the screws is inserted in the hub, for at least 12 mms for carbon propellers.



The use of a propeller not approved from Vittorazi can give rise to serious anomalies and immediately voids the warranty (see also the warranty chapters).

For Vittorazi the propeller is an integral part of the engine and should not be considered an extra part of the engine. The company has decided to invest in research and study of high-tech solutions, to have an ideal combination engine-propeller in many flight conditions. All approved propellers are designed in collaboration with Vittorazi engineers, with the aim of giving maximum performance and safety. Let's see some features guaranteed in the approved propellers:

- The adequate operation in optimal RPM-Range of engine and propellers.
- The best thrust during take-off and critical flight conditions, optimizing the energy transfer in a disturbed airflow.
- The best fuel consumption in all flight conditions, thanks to the most efficient profile and angle of attack.
- The optimization of the dynamic torque effects and static torque effect, through a lightweight structure and designing low resistance profiles.
- Avoiding resonant frequencies through optimized carbon fibre structure of the propeller and avoiding annoying vibrations along the entire RPM range.
- The correct balancing of the propeller by static and dynamical procedure, combined with a safe and precise mounting by CNC machined holes.
- The reduction of noise thanks to the best profiles and the tip speed below 0,65 Mach.

- Engine safety and reliability are given by the long endurance tests (200 hours) performed in extreme conditions with the approved propellers, to check if there are any critical issues before the production.



The engine warranty ends when the propeller, the engine, the aircraft has an accident.

After a propeller has broken, the engine is no longer safe. The engine must be completely checked by an authorized centre in every part of the system before resuming flight activity. This is also necessary for the rest of the aircraft. The statistics lead to the inspection of the following engine components:

- Reduction drive unit (propeller hub, bearings, reduction cases, main propeller shaft gears, screws, others).
- Engine carter case, engine rubber mountings, main screws.
- Exhaust system and silencer unit.
- Airbox system (airbox, sleeve, safety devices).
- More.

In case of damage of the propeller, replace it immediately with a propeller guaranteed by Vittorazi Motors. Replace in any case all screws of the propeller.

4.2 Fuel

Cosmos 300 engine requires a mixture of gasoline and oil to operate. Choose an open, ventilated, clean location away from dust, sand, grass and any foreign bodies that may come into contact with the mixture. If possible while refuelling, filter the mixture. Make sure that the fuel tank, filter and funnel, are always perfectly clean.



Gasoline is extremely flammable and explosive. Never fill the tank of your engine when it is running and do not prepare the mixture of petrol and oil near possible sources of ignition.



Vittorazi engines are approved with fuel that complies with the EU regulation UNI EN 228. Fuel 95 RON contain a maximum percentage of ethanol of 5 % in volume. The company has tested the wear limits of the mechanical parts with this fuel and the maintenance program is calibrated on this basis. Membranes, rubbers and carburettor seals can tolerate a maximum percentage of alcohol typical of European gasoline: 5 % ethanol, 3 % methanol and 10 % MTBE octane enhancer.

The use of inappropriate fuels (with higher Ethanol percentages and / or with lower RON) makes the engines leaner, up to overheating and breaking, thus bringing the user in serious danger. The use of unsuitable fuels also creates serious problems of corrosion and degradation of the engine materials. For these reasons, the use of different fuels that doesn't meet the required standards, leads to the voiding of the product warranty. When the available petrol doesn't meet the required standards, we recommend the use of AVGAS 100LL (Aviation Gasoline, 100 RON, Low Lead) in order to prevent any engine damage. Continuous use of AVGAS 100LL does not affect the engine warranty.



The oil we recommend is **Motul710** or **Motul800**, successfully tested in our engines. We have been running all approval tests for years with both of these oils.

- The **Motul710** is suggested for infrequent use, cross and discovery flights, with moderate and short climbs to max revolutions.
- The **Motul800** is suggested for frequent use, tandem, freestyle, competition, sportive and extreme use.

Avoid mixtures prepared at the petrol station. A mixture prepared 2-4 weeks earlier and left in a tank may separate (oil and petrol), losing its lubrication characteristics even if mixed before use.

Wrong oil-fuel mixture, non-compliant oils, wrong fuel or dirty fuel, other reasons already mentioned above, lead to voiding of the product warranty (see also the warranty paragraphs).

4.3 Start and stop



To test your aircraft on the ground, you have to be very careful. Carry out a checklist before starting the engine (chapter 5). Brake the aircraft in such a way that the thrust created by the rotation of the propeller does not cause any harm to you or other people near you. Shout CLEAR PROP! You can now start the engine. Be ready to turn off the engine at any time for safety reasons.



Filling the fuel line. Before starting the engine, the fuel line must be filled. To do this pull the choke control and hold it. Then simultaneously, activate the electric motor using the start button or pull the manual starter, until the fuel line is completely full and you hear the first strokes. Then leave the choke control at the neutral position and activate the start button or pull the manual starter again.



Cold engine starting. Throttle position at idle or less than 20 % open. In case of a difficult start, pull the choke control until you hear the first strokes.

Warm engine starting. Throttle position at idle. It is not necessary to refill the fuel line. When the fuel line is full and the engine is warm, it is not necessary to pull the choke control to start the engine.

Starting the engine when it is flooded. Full throttle opening. No choke activated. Extremely dangerous condition when performing this operation. Thrust may be violent and instantaneous in the event a sudden start.

The engine has a recoil starter with 3S technology (Soft Starter System). To correctly perform the starting procedure with the 3S system we suggest you to see the tutorials available on our channel. You will see how to grip the handle, how to perform a progressive pull on the handle, what to do to avoid damage.

<https://www.youtube.com/user/VITTORAZIMOTORS>



Electrical system warnings.

Disconnect battery after flight:

- It prevents voltage regulator and CDI leakage current to drain battery charge.
- It prevents accidental start of the engine.

Disconnect battery from the electrical system before recharging:

- Always use a battery charger suitable for the chosen battery to avoid any risk of explosion due to improper charging.
- When voltage regulator is used without battery it will fail.



Transport of the engine or long-term storage. The best position to carry the motor is the vertical one.

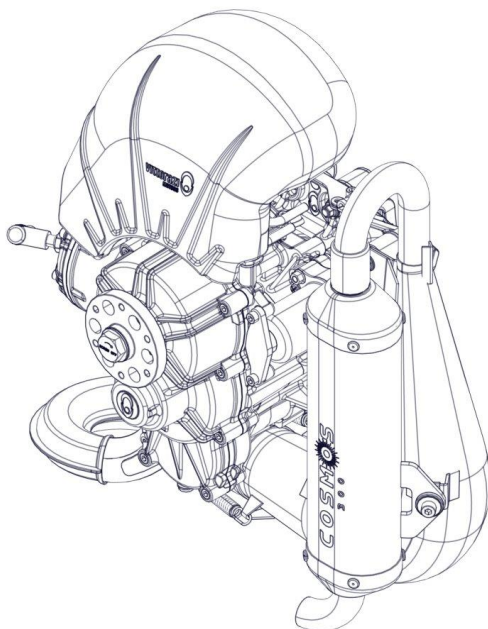

On the other hand, when the engine is in a horizontal position during transport, it is preferable to place it on the side of the manual start. If it is placed on the prop side, transmission oil may leak out of the breather valve. In such a case, clean the oil and check the level before use.

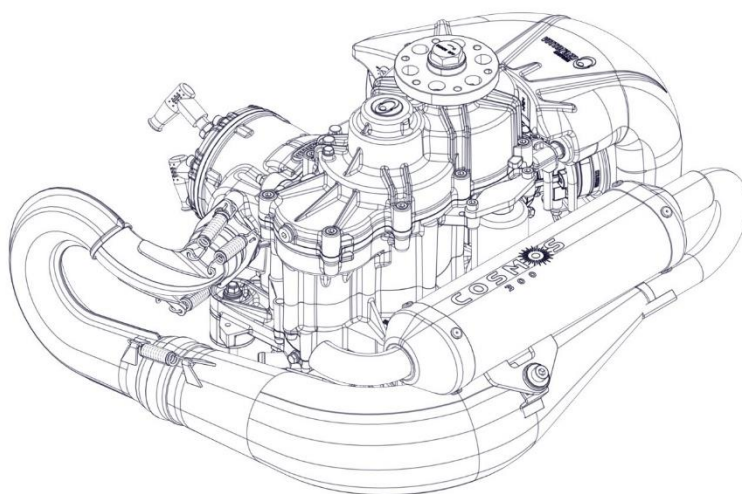

4.4 Engine warm up

Warm up the engine before use.

30 sec	Gently accelerate to stabilize engine and carburettor
2-6 min	Heat the engine at constant RPM (4.500 RPM) until liquid temperature reach 65 °C. If H2O sensor is not installed, heat the engine for about: <ul style="list-style-type: none">• 2-3 min with ambient air temperature above 15 °C;• 5-6 min with ambient air temperature below 15 °C.
15-20 sec	Keep FULL throttle
NOW the engine is ready to fly	



Be careful. The thrust generated by the propeller can be sudden and must be ensured with the right procedure when warming up the engine.



If the outside temperature is below 15 °C, cover the central part of the radiator (1) with the radiator band (2). The radiator band is an available option designed by Vittorazi.

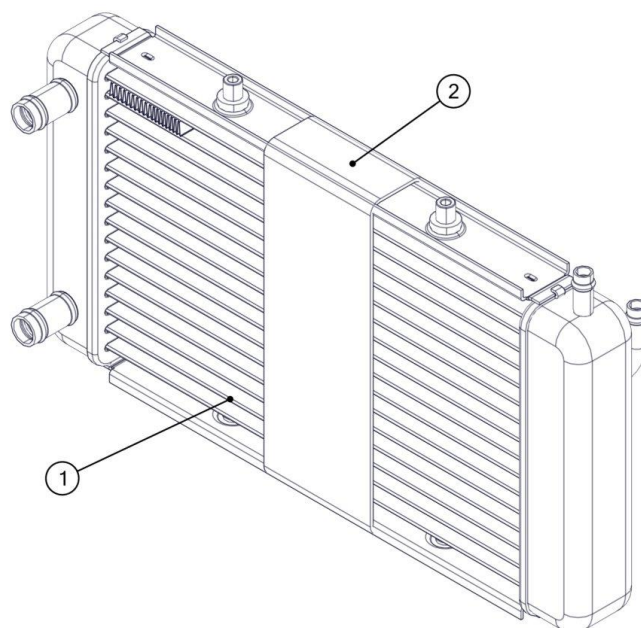

4.5 Break-in procedure

A carefully executed break-in phase, following the next instructions, improves the life of the engine and its performance. The presence of experienced personnel during the running-in phase is recommended, also to carry out the necessary checks at the end of the period.

The engine must be used carefully in the first hours of break-in (15 litres) and fuel mixture must be prepared as indicated in the table. The first time the engine is started, it must be warmed up on the ground for a few minutes, paying utmost attention to noises or abnormal behaviour. We recommend to complete the break-in on the same day.

Break-in	Cosmos 300
From 1 st to 15 th litre of fuel	Oil 2,5 % or 40:1 Motul710 Oil 2,0 % or 50:1 Motul800
After the 15 th litre of fuel	Oil 2,0 % or 50:1 Motul710 Oil 1,5 % or 66:1 Motul800

<p style="text-align: center;">Ground Break-in</p>	<p>Tools: chronometer and RPM counter; Test location: on the ground; Duration: about 2 hours in total; Test cycle: operating cycle of 13 working minutes followed by 15 minutes of cooling, to be repeated 4 times.</p> <table border="1" data-bbox="512 371 1158 994"> <thead> <tr> <th>RPM</th> <th>Time</th> </tr> </thead> <tbody> <tr> <td>4.000</td> <td>4 min</td> </tr> <tr> <td>Idle (1.800-2.000)</td> <td>1 min</td> </tr> <tr> <td>5.000</td> <td>3 min</td> </tr> <tr> <td>Idle (1.800-2.000)</td> <td>1 min</td> </tr> <tr> <td>6.000</td> <td>2 min</td> </tr> <tr> <td>Idle (1.800-2.000)</td> <td>1 min</td> </tr> <tr> <td>7.000</td> <td>1 min</td> </tr> <tr> <td>Off</td> <td>15 min cooling</td> </tr> </tbody> </table> <p>Final checks: carry out the checklist shown in the next chart before proceeding to the flight phase.</p>	RPM	Time	4.000	4 min	Idle (1.800-2.000)	1 min	5.000	3 min	Idle (1.800-2.000)	1 min	6.000	2 min	Idle (1.800-2.000)	1 min	7.000	1 min	Off	15 min cooling
RPM	Time																		
4.000	4 min																		
Idle (1.800-2.000)	1 min																		
5.000	3 min																		
Idle (1.800-2.000)	1 min																		
6.000	2 min																		
Idle (1.800-2.000)	1 min																		
7.000	1 min																		
Off	15 min cooling																		
<p style="text-align: center;">Flight Break-in</p>	<p>Test location: on flight; Duration: up to 15 litres (also include the fuel previously consumed on the ground break-in); Test cycle: each flight duration is up to 30 minutes.</p> <p>Do not keep the engine at max RPM for more than 30 seconds or do not keep constant RPM for a long time. Gradual accelerations and releases are recommended.</p>																		
<p style="text-align: center;">Regular use</p>	<p>Use engine with mixture of oil 2,0 % Motul710 or 1,5 % Motul800.</p>																		

At the end of the ground break-in perform the following checks:

Engine screws and nuts tightening;
Propeller screws tightening;
Engine idle;
Carburation from spark plug colour;
Rubber mountings;
Airbox fixing;
Pull starter system / Electric starter;
Exhaust bushing joints (correct sliding, no leaks);
Coolant level;
Gearbox oil level; transmission oil replacement, suggested;
All installed components (engine fixing, electrical system, fuel line system, instrumentation, other parts).



Carry out the above operations in accordance with the installation, use and maintenance manual and under the supervision of authorized personnel.

5 Safety first, check it

5.1 Maintenance schedule

Refer to the following maintenance indicated time schedule to fly in total safety. Work on the engine is only allowed to be carried out by experienced mechanic and authorized dealers. These are prescribed checks at certain interval times to avoid engine problems through preventative maintenance.

Caption:



Cleaning



Check



Measuring





















Replacement





















Lubricate with WD-40

Note:













- 1) or after a year
- 2) rope, spring, hooks or a new pull starter system
- 3) springs
- 4) each time the component is disassembled
- 5) head, exhaust port, decompressor hole
- 6) when the hoses are disassembled replace the clamps
- 7) or after 2 years

Flight hours	Before each flight	Every 10 h	Every 25 h	Every 50 h	Every 100 h	Every 150 h	Every 200 h
Pre-flight checklist							
Screws and nuts (tightening)							
Carburation from spark plug colour							
Spark plugs							
Spark plugs connectors							
Carburettor							
Carburettor membranes						 1)	
Airbox Snaplock							
Airbox			 				
Airbox sponge and sleeve			 		 1)		
Reed valve petals							
Pull starter system					 2)		

The table follows in the next page

Flight hours	Before each flight	Every 10 h	Every 25 h	Every 50 h	Every 100 h	Every 150 h	Every 200 h
Electric starter							
Kit exhaust bushing (1 st joint)							
Exhaust bushing (2 nd joint)				  3)			
Exhaust manifold with springs							
Soundproofing material silencer							
Silencer rubbers						 1)	
Gaskets (head, cylinder, carburettor, reed valve, exhaust, transmission, water pump)					 4)		
Piston					 		
Piston roller bearing							
Head and cylinder					 5) 		

The table follows in the next page

Flight hours	Before each flight	Every 10 h	Every 25 h	Every 50 h	Every 100 h	Every 150 h	Every 200 h
Coolant						 1)	
Radiator hoses					 6)		
Radiator rubbers							 7)
Rubber mountings (engine, exhaust)						 1)	
Oil seal carter case							
Crankshaft bearings							
Crankshaft							
Gearbox oil							
Transmission bearings							
Centrifugal clutch							
Clutch bell							

5.2 Tightening values

Component	Torque value	Thread size	Lubricant/ sealant
Engine carter screws	10 Nm	M6x50	
Carter support screws	20 Nm	M8x55	
Cylinder studs	20 Nm	M8	
Cylinder nuts	17 Nm	M8	
Cylinder head screws	10 Nm	M6x30	
Spark plug	25 Nm	M14x1,25	
Exhaust studs	25 Nm	M8	Loxéal 83-55/ Loctite 270
Exhaust nuts	32 Nm	M8	Copper paste
Exhaust support plate's nuts	18 Nm	M8	
Silencer fixing screws	13 Nm	M8	
Carburettor flange screws	10 Nm	M6x30	
Carburettor screws	hand tightening	M6x16	Loxéal 83-55/ Loctite 270
Carburettor flange studs	10 Nm	M8	Loxéal 83-55/ Loctite 270
Self-locking nuts	16 Nm	M8	
Screw fixing safety band support plate	8 Nm	M5x20	Loxéal 55-03/ Loctite 243
Snaplock airbox pivots	10 Nm	M6	Loxéal 55-03/ Loctite 243
Airbox fixing clamp	2,5 Nm	50-70 mm (clamp size)	
Flywheel nut	90 Nm	M12x1,25	

The table follows in the next page

Stator screws	10 Nm	M6x25	
Aluminium toothed pulley's screws	10 Nm	M6x20	Loxéal 55-03/ Loctite 243
Pick up screws	8 Nm	M5x12	
Transmission carter screws	10 Nm	M6x30	
Propeller hub fixing screw	20 Nm	M8	Loxéal 24-18/ Loctite 222
Clutch nut	100 Nm	M14x1,5	
Counter-rotating shaft nut	72 Nm	M12x1,25	
Clutch plate screws	8 Nm	M5x14	
Manual starter screws	10 Nm	M6x25	Loxéal 24-18/ Loctite 222
Starter central pin screw	17 Nm	M8x25	Loxéal 83-55/ Loctite 270
Water pump cover screws	8 Nm	M5x20	
Pump impeller nut	8 Nm		
Electric starter screws	10 Nm	M6x35	
Electric starter fixing plate's screws	10 Nm	M6x20	
Pipe support bracket screws	10 Nm	M6x14	Loxéal 83-55/ Loctite 270
Carbon propeller screws	12-14 Nm	M8	

5.3 Carburettor setting

L and **H** adjustments of the carburettor screws in their standard positions ensure correct engine performance, optimal operating temperature and best lubrication of all parts. Carburation is correct if:

- The engine maintains a constant idle (1.800-2.000 RPM) and does not tend to turn off or flood.
- In rapid acceleration from low RPM, engine reacts immediately without power gaps or shutdown.
- At cruising RPM (approximately 5.000-6.000 RPM), engine provides a regular and smooth thrust.
- At max RPM (full throttle), thrust is constant and the RPM is between 7.300-7.650 RPM.

The idle screw is free and the position can be changed until the right RPM is reached. The two screws L and H are sealed for safety reasons. Check that both carburettor screws are sealed and in the correct position with respect to the marks. If the engine shows any of the problems listed above, the carburettor should be checked by an authorized dealer.

Setting	Cosmos 300
Screw L	34±2 minutes (sealed for warranty purposes)
Screw H	74±2 minutes (sealed for warranty purposes)
Idle	1.800-2.000 RPM

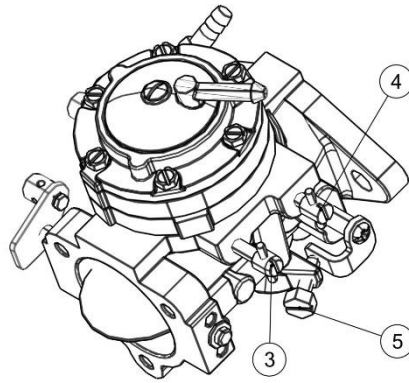
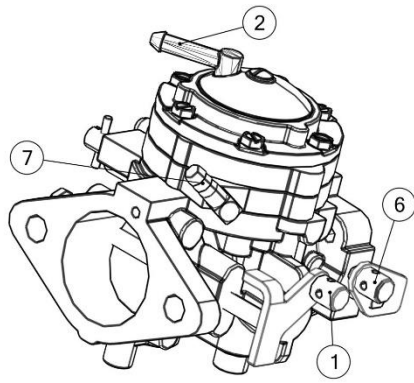

- 1 Throttle lever
- 2 Gasoline inlet
- 3 High speed screw
- 4 Low speed screw
- 5 Throttle adjustment
- 6 Choke lever
- 7 Pulse line inlet



Screw L and H of the carburettor is sealed by Vittorazi Motors to ensure the safety of operation. Incorrect setting of screw H can result in serious damage. If the opening of the settings is lower than the table specifications, the mixture will be poor and there is the possibility of breaks, such as seizure, overheating, piston melting, early wear of the components. Wrong carburettor settings, or breakage of the L and H seal, lead to voiding of the product warranty (see also the warranty paragraphs).

A second check of the carburetion can be made verifying the colour of the spark plug electrode. A first control can be done, at the end of the of break-in period, in the following way:

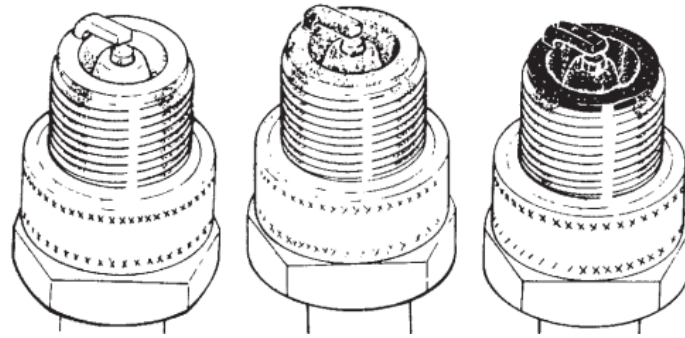

Light Grey / Grey

Brown / Cappuccino

Black / Dark / Wet

Electrod colour	Carburetion quality
Light grey / Grey	The carburetion is poor, lean. It is important to find the cause immediately, with the help of an authorized dealer / instructor.
Brown / Cappuccino	Normal, Optimal, Correct.
Black / Dark / Wet	The carburetion is rich. It is important to find the cause immediately, with the help of an authorized dealer / instructor.

5.4 Pre-flight checklist

Check propeller screws tightening .
Visually check the engine integrity and oil leaks : rubber mountings, muffler, airbox fixing, transmission, cylinder head and all the other components.
Visually check the fuel line, coolant level, electric cables and components.
Verify that throttle joystick sliding is correct, in its upper and lower limits.
Fill the fuel line following the procedure.
ENGINE IS NOW READY TO START.
Place your aircraft in a safe position to start the engine .
Shout CLEAR PROP! Start the engine.
Complete the engine WARM UP procedure.
Check for abnormal vibrations or noise .
Check that Max RPM is between 7.300 and 7.650 .
Check that engine keeps the Max revs for at least 5 seconds .
Check the engine idle, so the RPMs are stable between 1.800 and 2.000 RPM .
Switch off the primary and secondary coils alternately to verify the correct functioning of the twin spark system (only twin spark version).
Turn off the engine to check the correct operation of the killing switch button .
ENGINE IS NOW READY TO TAKE OFF.

5.5 Spare parts

Ask to a Vittorazi dealer for the spare-parts. If a dealer is not available in your area or country, you can contact the nearest Vittorazi dealer (or directly the factory).

The use of not original parts and parts not recognized by Vittorazi, can make the motor dangerous and this immediately voids the warranty. Vittorazi doesn't accept any warranty for those motor used with not original parts, parts not recognized, modified motors or those who have been used improperly.

You can download the Vittorazi Motors Illustrated Parts Catalogue (IPC) directly from the website. The manufacturer will ensure immediate availability of spare parts.

IPC, manuals, bulletins, newsletter, warranties, FAQ

<https://www.vittorazi.com/en/services/>



Find the nearest dealer

www.vittorazi.com/en/dealers/



Vittorazi Official YouTube channel: video and free tutorials available

<https://www.youtube.com/user/VITTORAZIMOTORS>



6 Warranty

On all the motors sold by Vittorazi Motors from January 1st 2022, will be applied the new warranty conditions indicated in this manual.

6.1 Warranty limits

This warranty remains in force for a period of 2 years / 150 hours of use, means that the engine is covered for 2 years from the date of purchase or 150 hours of use - whichever occurs first. To keep your warranty valid for up to 150 hours, you must follow a maintenance schedule as outlined in the manuals and record the service work in the following document (service booklet). An hour meter integrated in the aircraft is required, always working and well installed to the engine. This warranty does not cover repairs, replacement of components or provision of services after the warranty expiration date.

Any procedure of installation, maintenance and/or repair of the products must be carried out exclusively with the original Vittorazi Motors parts and tools specified by Vittorazi, in compliance with the specifications contained in the user, installation and/or maintenance manual of the products; to ensure maximum safety and performance of the products, the above-mentioned procedures will be carried out by mechanics with proven experience in the ultralight aviation or general aviation or with experience gained by Vittorazi Motors professional training courses. Failure to do so, will held harmless the company from any liability for any damage due to the malfunctioning and immediately void the warranty of the product.

6.2 Warranty procedure

Any warranty claim must be requested from the product owner to the authorized dealer within ten (10) days of discovering the anomaly. The owner has to show the copy of the "proof of purchase" of the product, such as the bill or commercial invoice of the engine or the entire aircraft, together with the "service booklet". Vittorazi Motors can request at its own discretion, the invoice of the original spare parts bought and/or the invoice of the service performed by mechanics with proven experience, as further proof of the accomplished maintenances.

The dealer has in charge the complete filling of the proper "Warranty Form" and the sending to the Vittorazi Motors headquarters for the acceptance. The dealer is the only official channel to activate a request of warranty: the requests received through direct mailing, social post, telephone contact, won't be taken in consideration from Vittorazi Motors. Once the request is accepted, the dealer will be the responsible to plan the inspection and the reparation of the product, as long as the motor is covered by the warranty. Vittorazi Motors undertakes to deliver the replacement parts under warranty to the head office of the dealer / aircraft manufacturer. All the shipping expenses that are necessary from the head office of the dealer to the address of the client, will be not in charge of Vittorazi Motors.

Vittorazi Motors may require to return the anomalous parts or components for evaluation prior or subsequent to the approval of any warranty. In this case the shipping costs will be on charge of Vittorazi Motors from the address of the client to the factory headquarter. All the parts replaced, both defective or non-compliant, during the interventions of warranty, will become property of Vittorazi Motors. The company can also require a proof of destruction of the broken parts instead of their return, at its own discretion.

6.3 Warranty coverage

This warranty covers engine damage caused by: components that are defective in form or material, design or assembly error from the factory. By using a new engine, the owner agrees that these terms and conditions have been accepted at the time of purchase of the product. Accordingly, under this warranty, the company's obligations shall be limited to repairing the defective component and/or replacing one or more components, or as necessary to restore full engine functionality.

Improper use of the products or improper technical service (in relation to the specifications contained in the user, installation and maintenance manual) **will held harmless exempt the company from any liability for any damage due to the malfunctioning and immediately void the warranty of the product.** Here are listed most of the reasons.

- improper use or mistreatment of the engine by the user, such as:
 - any neglect or omission of generic controls;
 - any lack of maintenance at the specified time intervals;
 - use of the engine already affected by any damage;
 - use of the engine with a non-approved propeller;
 - use of the engine with a damaged or unbalanced propeller;
 - use of the engine with a wrong combination propeller/reduction ratio;
 - use of wrong fuel, wrong mixture oils, wrong fuel/oil mixture percentage, fuel stored for excessive time;
 - use of inadequate fuel for presence of water, additives, impurities;
 - use of the engine with liquids, lubricants that are not compatible with the engine;
 - incorrect warm-up procedure;
 - incorrect break-in procedure;
 - other reasons described in the manuals.
- use of the engine that has exceeded any limit recommended by the engine manufacturer, e.g. max engine RPM, cylinder head temperature (CHT), exhaust gas temperature (EGT), fuel consumption;
- use of the engine for racing or any other competitive activity;
- use of non-original components Vittorazi Motors, non-compliant accessories, other items not approved for the engine;
- not authorized modification from original configuration of the product (e.g. the drilling of the exhaust manifold);
- any incorrect carburetor setting and/or a broken seal on the adjustment screw;
- improper technical service in relation to the specifications contained in the user, installation and maintenance of the engine;
- any incident affecting the engine and/or the propeller, or even a single component of the aircraft;
- missing or incorrect implementation of any service bulletin issued by the company;

- any incident involving the engine and/or the aircraft, related to fire, lightning strike, water landing, transport, storage and any other factor out of Vittorazi's control.

The following cases are not guaranteed under any circumstances:

- replacement of normal wear and tear or service items (such as spark plug, belt, membranes, gaskets, liquids and more);
- any failure or malfunction resulting from piston seizure, piston scuffing, and any damage resulting from lack of lubrication (including related damage to cylinder, head, crankshaft, bearings, etc.);
- any failure or malfunction due to ingestion of foreign objects (e.g., dirt inside or outside the product, corrosion, ingestion of water, ice, sand, other) or any other damage due to the operating environment;
- further maintenance interventions required by the client, besides those covered by the warranty.

The following are not covered by warranty or compensation:

- damage caused to persons/animals/things caused by general use of the engine;
- damage caused to persons/animals/things, caused by collision with any part detached from the engine;
- damage caused to the aircraft components and/or propeller, caused by collision with any part detached from the engine;
- recovery, shipping, telephone or rental costs of any kind, inconvenience or loss of time, or other consequential damages.

For any question about the warranty coverage, contact the authorized dealer, that can provide further information.

6.4 Contacts

For any questions, claims, doubts or problems with the operation of the engine, do not hesitate to contact us. We will always be ready to help you.

Check out our list of information channels and follow us constantly to stay updated.

Find the nearest dealer

www.vittorazi.com/en/dealers/



Vittorazi Newsletter: to receive exclusive information and obtain technical safety updates

<https://www.vittorazi.com/en/newsletter/>



Facebook official page: follow us and catch commercial promotions

<https://www.facebook.com/vittorazimotors/>



Facebook official group: support our initiatives and share your experiences with us

<https://www.facebook.com/groups/VittoraziMotorsSupportOnline/>



Service booklet

Owner's data

Name and last name

Address
(Street, City & Country)

E-mail address

Telephone number

Engine's data

Engine model

Engine serial number

CRC

Date of purchase

Dealer / Distributor / Seller

Hours	Operations	Flight hours	Date	Dealer Signature & Stamp
25	Suggested maintenance			
50	Mandatory maintenance			
75	Suggested maintenance			
100	Mandatory maintenance			
125	Suggested maintenance			
150	Warranty expiry			

